



Australian Government

Patent Office

Canberra

I, ALEX THOMSON, PATENTS & PLANT BREEDER'S RIGHTS ADMINISTRATION hereby certify that annexed is a true copy of all documents as filed in connection with Australian Patent Application No. 54015/99 which are available under the provisions of the Patents Act 1990.

WITNESS my hand this

Twenty-ninth day of January 2015

A handwritten signature in black ink, appearing to be 'Alex Thomson'.

ALEX THOMSON

PATENTS & PLANT BREEDER'S  
RIGHTS ADMINISTRATION



015 1999

of Filing

14 OCT 1999

# Application for STANDARD PATENT Complete

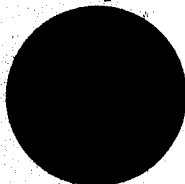

Serial No:

Divisional of:

Additional to:

C4

Associated with

No ..... Filed .....

### Proceedings

Folio No.

Referred to

Date

Clearing Officer

Date Cleared

O.P.I. Advertised

4.5.00

3  
6

**PFU/AB**

PFU

19/11/99

10.11.99

PFU

30/M

22/11

7.12.99

Abstract Completed

Microfilmed,  
Date and Batch

Advertised Accepted

**LAPSED S.142(2)(a)**

Voluntary Amendment  
Request Advertised

Allowance Advertised

Sec 104 Advertised

Sec 113 Advertised

Extension of Term Filed

Extension of Term Granted

Advertised Lapsed,  
Refused or Withdrawn

28 FEB 2002

Other Proceedings

Sec 223 Advertised

Sec 223 Allowance Advertised

### Continuation Fees

Response fees due after

Primary Examiner

In Force To

Date

Initials

12

# CORRESPONDENCE

Discovery House, Phillip ACT 2606  
PO Box 200, Woden ACT 2606  
Australia  
Phone +61 -2 6283 2211  
Facsimile +61 -2 6285 3593  
Internet <http://www.ipaustralia.gov.au>

7 December, 1999

DAVIES COLLISON CAVE  
1 Little Collins Street  
MELBOURNE VIC 3000

Re: Patent Application Number 54015/99 in the name of  
Datum, Inc.

Your Ref: 2224523

Receipt is acknowledged on 25/11/99 of your substitute  
documents relating to the above patent application. These  
documents have been substituted and the specification now  
complies with the formal requirements.

Tracey JOHNSTON  
Patent Filing  
02 62832320

DAVIES COLLISON CAVE  
PATENT & TRADE MARK ATTORNEYS



64



25 November, 1999

Batch No. 55805

Customer No. 40000361

The Commissioner of Patents  
WODEN ACT 2606

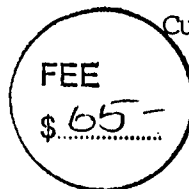

Our Ref: 2224523/KL

Re: Datum, Inc.  
Australian Patent Application No. 54015/99  
"Controlling access to stored information"

Sir,

With reference to your notification of 22 November 1999, we enclose:

Official Fees \$65.00

Yours respectfully  
DAVIES COLLISON CAVE

JULIE FAWBERT

Davies Collison Cave  
PATENT & TRADE MARK  
ATTORNEYS

Melbourne

1 Little Collins Street  
Melbourne, Victoria  
Australia, 3000

GPO Box 4387QQ  
Melbourne, Victoria  
Australia, 3001

Telephone:  
+61 3 9254 2777  
Facsimile:  
+61 3 9254 2770  
E-mail:  
mail@davies.com.au  
Web site:  
http://www.davies.com.au

Other Offices:  
Sydney  
Canberra

In association with:  
DaviesCollison Cave Solicitors  
Intellectual Property Law

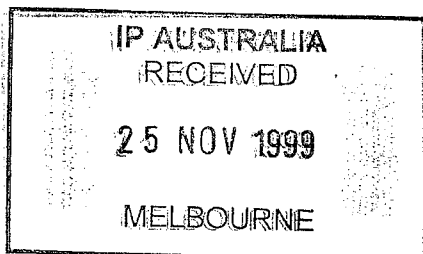

Davies Collison Cave  
Melbourne

DATE: 22/11/99

BATCH NUMBER: 55805  
(PLEASE QUOTE BATCH NUMBER  
WHEN MAKING PAYMENT)

**NOTICE OF PAYABLE FEES**

PATENT APPLICATION NUMBER : 54015/99

APPLICANT : DATUM, INC.

REFERENCE : 2224523/KL

I HEREBY NOTIFY YOU THAT FEES WERE PAYABLE FOR SUBSTITUTING/ADDING DOCUMENTS WHICH HAVE NOT BEEN PAID, AS DETAILED BELOW.

- SEE SECTION 227(5) AND REGULATION 22.2A

THE DOCUMENT PROVIDED BY YOU WILL BE TAKEN NEVER TO HAVE BEEN FILED IF YOU FAIL TO PAY THE AMOUNT UNDERPAID ON OR BEFORE ONE MONTH FROM THE DATE OF THIS NOTICE.

- SEE SECTION 227(5)(6)(B)

TOTAL AMOUNT DUE:	\$65.00
AMOUNT PAID:	\$0.00
AMOUNT UNDERPAID:	\$65.00

*Please annotate your payment to the attention of Tracey Johnston, Patent Filing Unit.*

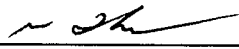
  
\_\_\_\_\_

**Manager, Patent Filing Unit**

22 November, 1999

DAVIES COLLISON CAVE  
1 Little Collins Street  
MELBOURNE VIC 3000

Re: Patent Application Number 54015/99 in the name of  
Datum, Inc.

Your Ref: 2224523

Receipt is acknowledged of substitute documents on 17/11/99

Patent Regulations stipulate that a fee is payable on filing  
substitute pages in compliance with the formal requirements.

As a direction was issued on 19/10/99 a fee of \$ 65.00 is  
payable before the substitute documents can be processed.

Ian RENNELL  
Patent Filing  
02 62832320

DAVIES COLLISON CAVE  
PATENT & TRADE MARK ATTORNEYS



17 November, 1999

The Commissioner of Patents  
WODEN ACT 2606

**Our Ref:** 2224523/KL

**Re:** Datum, Inc.  
Australian Patent Application No. 54015/99  
"Controlling access to stored information"

Sir,

We enclose:

Certified Copy of USSN 09182342; and

Formal Drawings (6 sheets) and true copy thereof

Yours respectfully  
DAVIES COLLISON CAVE

JULIE FAWBERT

**Davies Collison Cave**  
PATENT & TRADE MARK  
ATTORNEYS

**Melbourne**

1 Little Collins Street  
Melbourne, Victoria  
Australia, 3000

GPO Box 4387QQ  
Melbourne, Victoria  
Australia, 3001

Telephone:  
+61 3 9254 2777  
Facsimile:  
+61 3 9254 2770

E-mail:  
mail@davies.com.au

Web site:  
<http://www.davies.com.au>

**Other Offices:**  
Sydney  
Canberra

In association with:  
DaviesCollison Cave Solicitors  
Intellectual Property Law

**IP Australia**  
Documents received on:

17 NOV 1999

Melbourne

Batch No:

55805



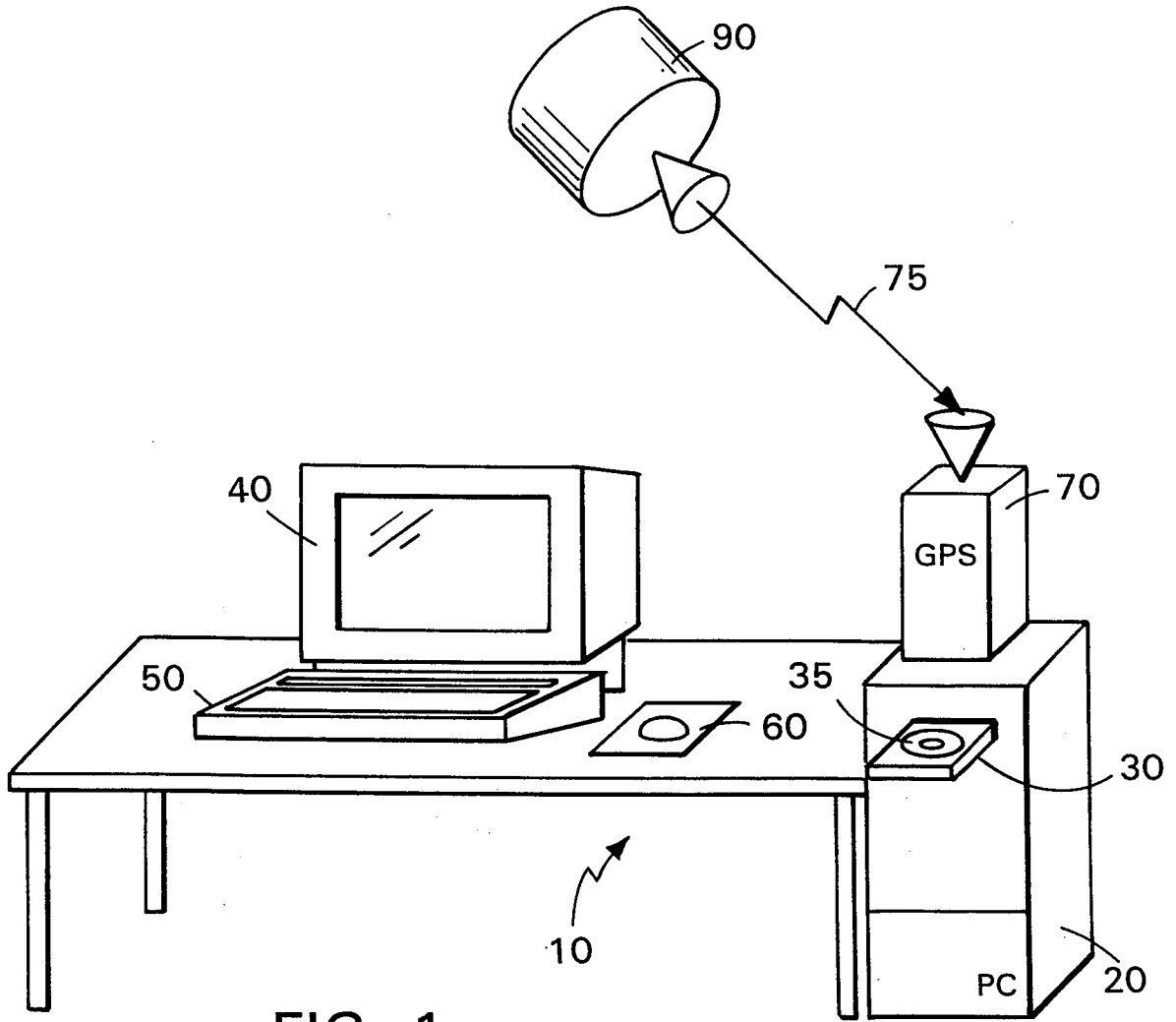
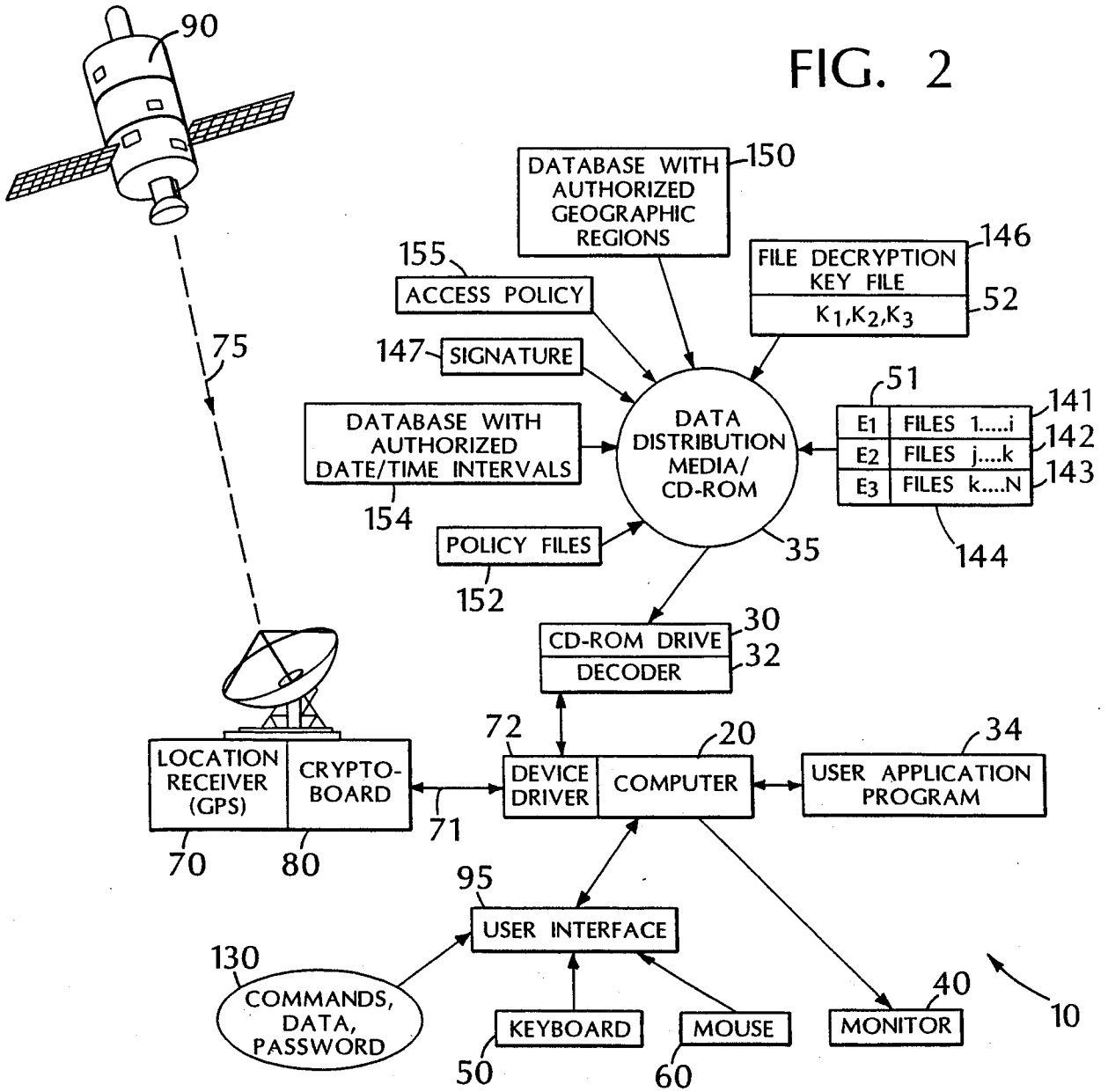

FIG. 1

FIG. 2



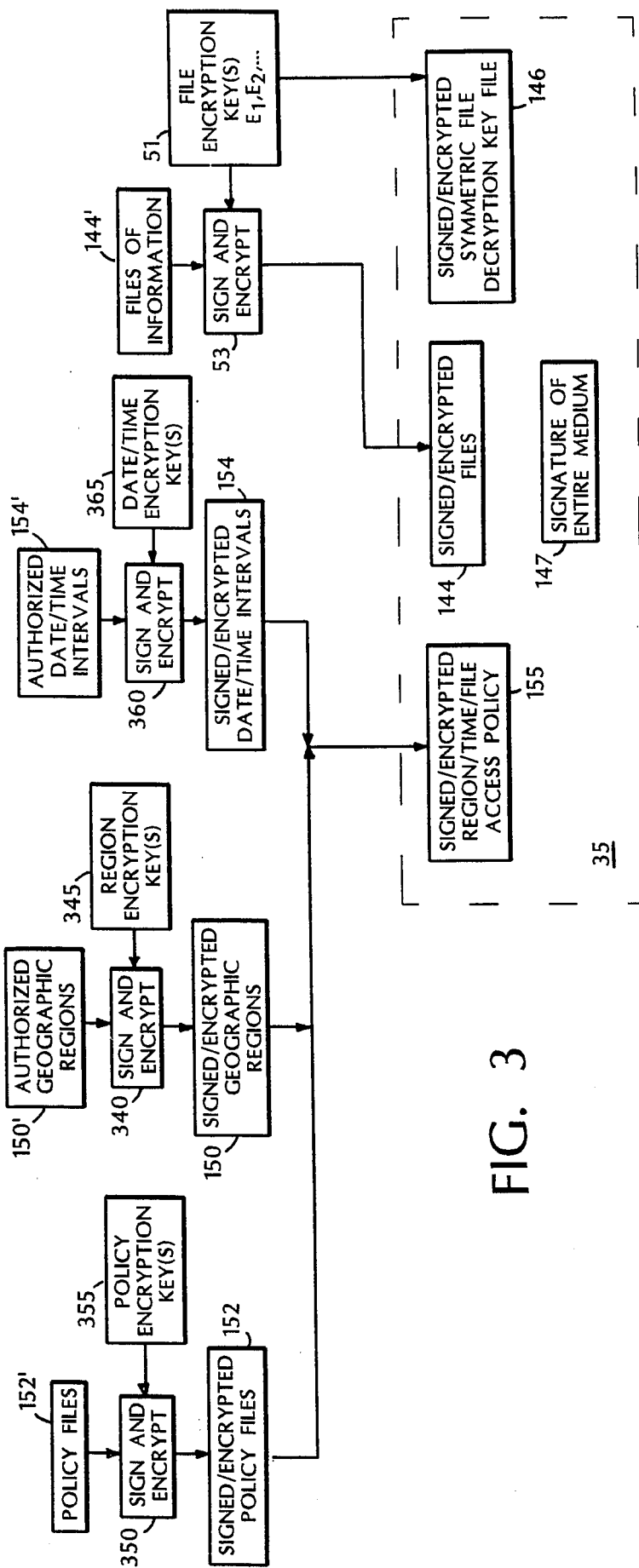
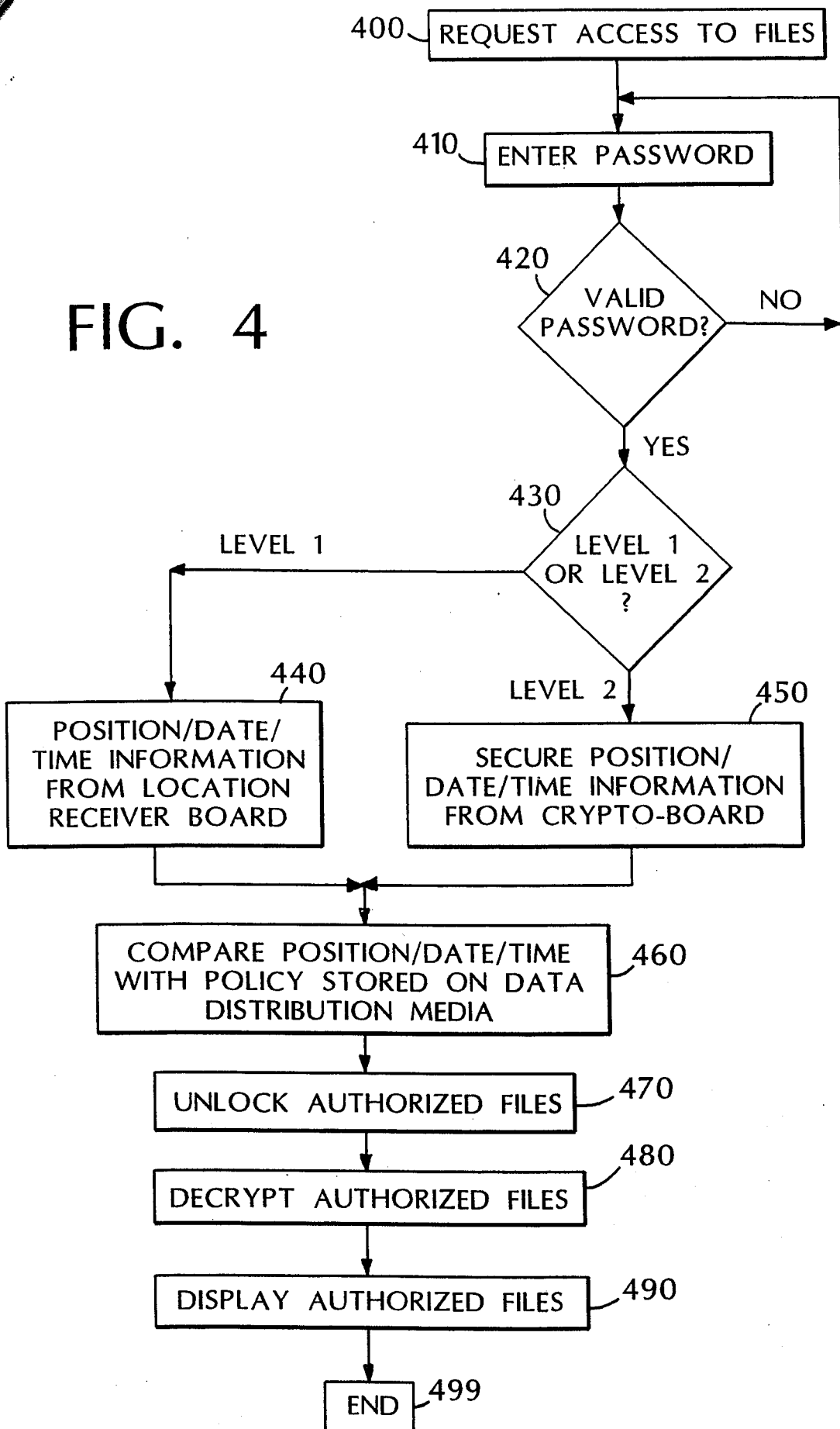

FIG. 3

FIG. 4



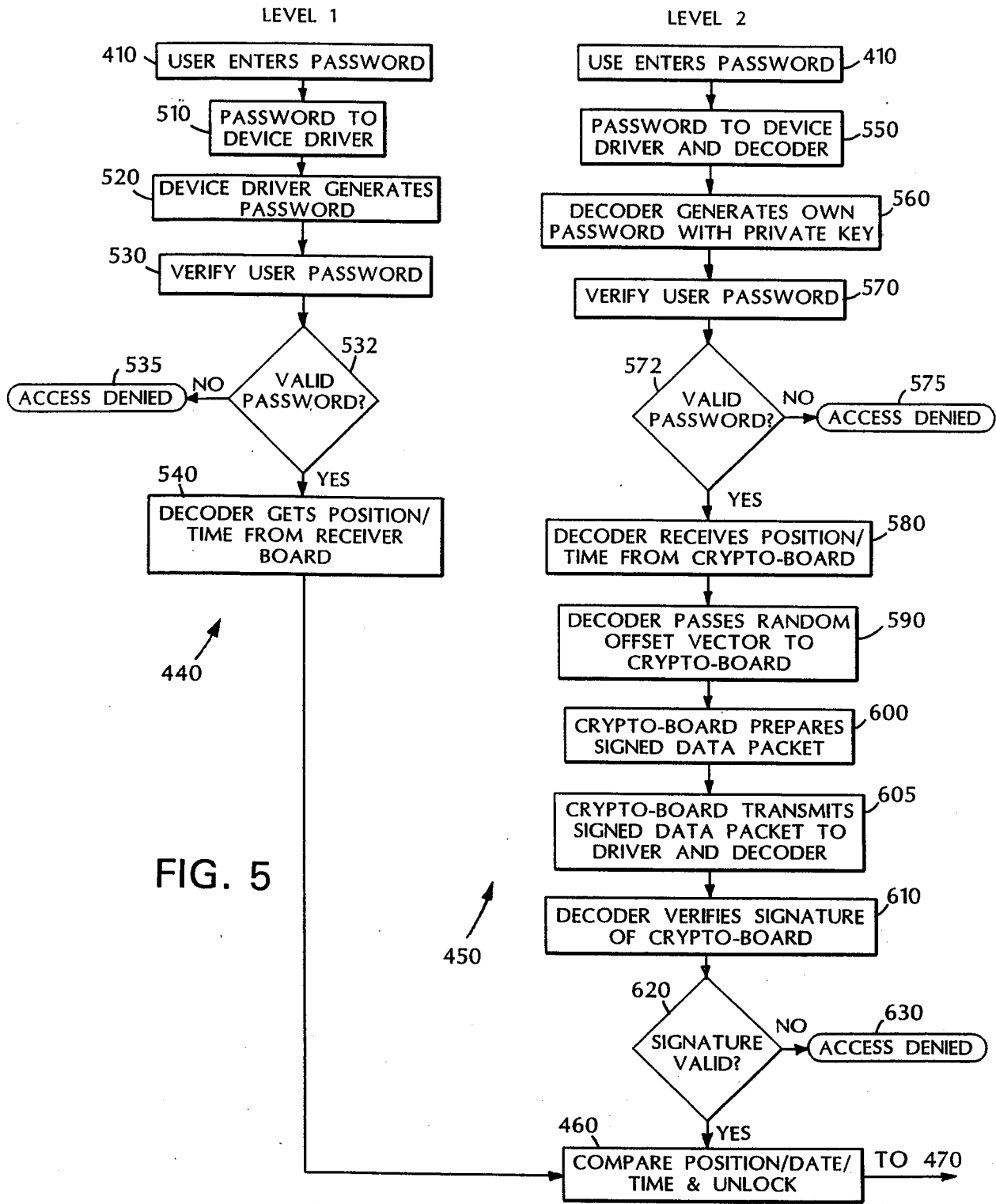

FIG. 5

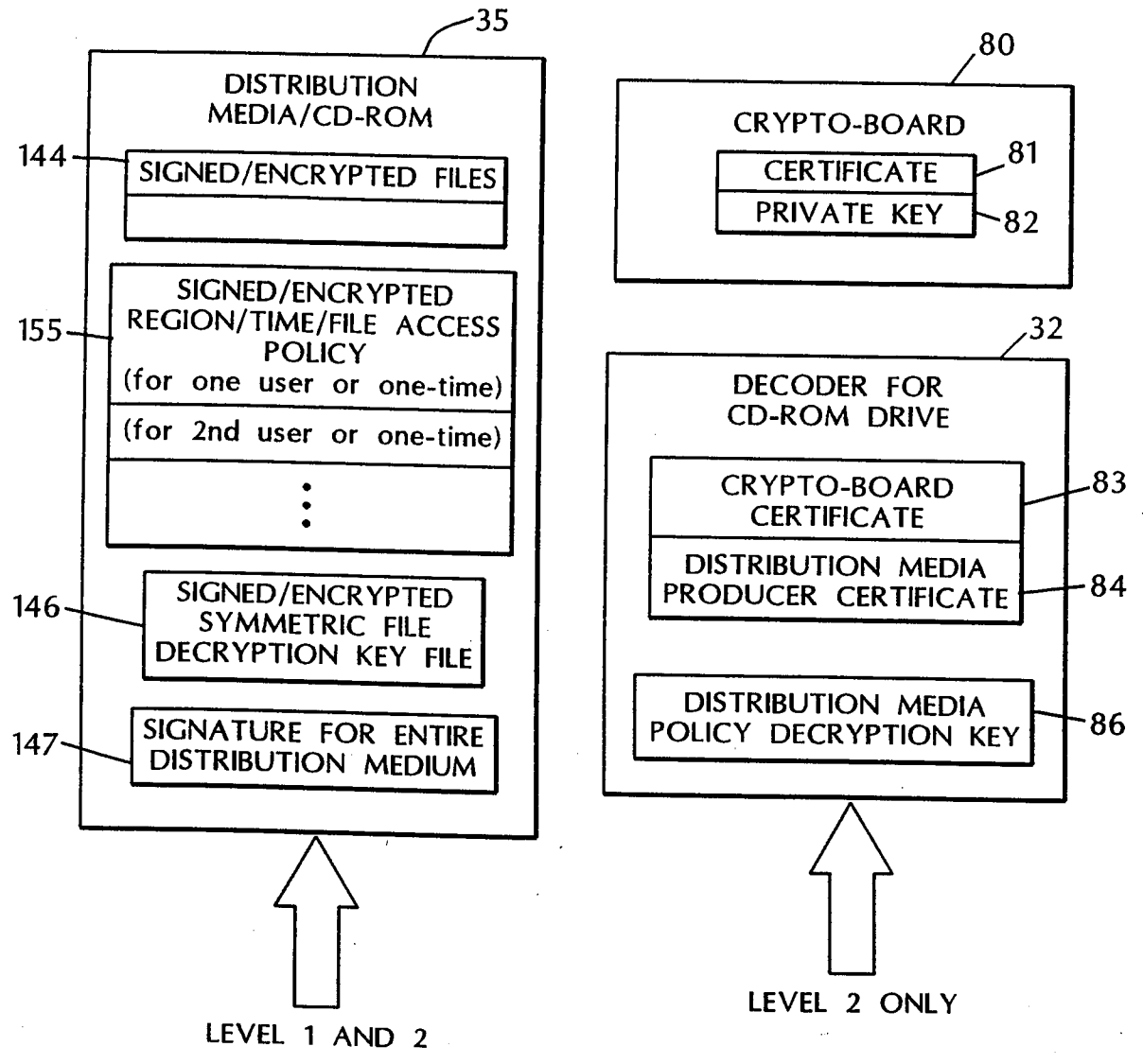

FIG. 6

Formalities Report - 54015/99

---

Reference : 2224523

Specification and Drawings

---

The following pages do not comply with the requirements of the Third Schedule of the Patent Regulations and you are directed to file substitute pages

Drawings	Page Numbers
-----	-----
Suitability for Photographic Reproduction	: Informal drawings

If this direction is not complied with within the time referred to in regulation 3.2(5) this application will lapse.

DAVIES COLLISON CAVE

Patent Attorneys

1 Little Collins St., Melbourne, 3000, Australia  
Telephone 03 9254 2777 Pat.Office Speed Dial 524

54015/99

FEE  
\$ 280-

14 October 1999  
Our Ref: 2224523/AXD

The Commissioner of Patents  
WODEN ACT 2606

Sir

Re: New Patent Application in the name of Datum, Inc.

We enclose the following:

Patent request: standard patent

Complete specification and true copy thereof

Abstract (in duplicate)

Informal drawings

Official fee - \$280.00

Yours faithfully  
DAVIES COLLISON CAVE

*JM Lambert*

ANDREW DARK

IP Australia

Documents received on:

14 OCT 1999

Melbourne

Batch No:



AUSTRALIA

PATENTS ACT 1990

PATENT REQUEST : STANDARD PATENT

I/We being the person(s) identified below as the Applicant(s), request the grant of a patent to the person(s) identified below as the Nominated Person(s), for an invention described in the accompanying standard complete specification.

Full application details follow:

[71/70] Applicant(s)/Nominated Person(s):

Datum, Inc.

of

54 Middlesex Turnpike, Bedford, Massachusetts, United States of America

[54] Invention Title:

Controlling access to stored information

[72] Name(s) of actual inventor(s):

Thomas MARK HASTINGS  
Michael E. MCNEIL  
Todd S. GLASSEY  
Gerald L. WILLETT

[74] Address for service in Australia:

DAVIES COLLISON CAVE, Patent Attorneys, 1 Little Collins Street, Melbourne,  
Victoria, Australia. Attorney Code: DM

Basic Convention Application(s) Details:

[31] Application Number	[33] Country	Code	[32] Date of Application
09182342	United States of America	US	29 October 1998

DATED this FOURTEENTH day of OCTOBER 1999

IP Australia  
Documents received on:

14 OCT 1999

Batch No:

Melbourne

*Keith Gosh*

a member of the firm of DAVIES  
COLLISON CAVE for and on  
behalf of the applicant(s)

# Patent Abstract Worksheet AU-A1

Application No.

# 54015 1999

(24) E.P.D. (if different from earliest date at INID 32) / / (AU priority or Additional)

(31) Priority Document No(s)  
(earliest first)

09182342

(32) Date of Filing (33) Country Code

29/10/98

US

/ /

/ /

/ /

(54) Title (if edited title on patent request unsuitable)

(60) Associated with  
Application Nos.

(61) Additional to  
Application No.

(62) Divisional of  
Application No.

(57) Abstract Material

Claim No. or Claims

Drawing Sheet No.

--	--	--

2/6		
-----	--	--

Applicant's  
Abstract

Page

Lines

Overflow space (use plain paper if this space is insufficient)

Abstract by (Block letters)

PCS

Sub-Section

C4.

Supervised or sighted by (Block letters)

# Information Sheet

## Search Strategy

Sort

Remarks

G06F  
G11P  
G07K

No Sub Section	Suggested Sub Class	Because of page/lines, claim	Action taken	Action by	Supervised or sighted by

Normal Examination

Modified Examination

## Search Strategy

Foreign search <input type="checkbox"/> US <input type="checkbox"/> GB <input type="checkbox"/> EP <input type="checkbox"/> WO <input type="checkbox"/> <input type="checkbox"/>	Years searched	Claims searched
International class(es)		
Australian class(es):		
M.B.S.S.		

## Search Results

Family members	CC	PATENT No.	APP. No. IF AU	CLASS MARKS IF AU

Other publications: *(books, catalogues, magazines)*

1st Report by: *(Block letters)*

Supervised by: *(Block letters)*

INTERNATIONAL CLASSIFICATION INDEXING SHEET

KA

EXAMINER IDENTIFICATION

NAME	UNIT
PCIS	CH

PRIORITY DOCUMENT

COUNTRY CODE	APPLICATION NO (L.H. Zero)	YEAR	COUNTRY CODE	NUMBER * Start
AU	5401599	99	US	09182342

Leave current or enter required edition

	SUB-CLASS	MAIN GROUP (L.H. Zero)	SUB-GROUP Start	VERS	PRIMARY CLASS	SUB-CODE *	ANNOTATION *
1	G.0.6.F	0.1.2	14	<input type="checkbox"/>	<input type="checkbox"/>	<input type="checkbox"/>	
2	G.0.6.B	0.3.1	20	<input type="checkbox"/>	<input type="checkbox"/>	<input type="checkbox"/>	
3	G.0.7.F	0.1.9	0.0	<input type="checkbox"/>	<input type="checkbox"/>	<input type="checkbox"/>	
4				<input type="checkbox"/>	<input type="checkbox"/>	<input type="checkbox"/>	
5				<input type="checkbox"/>	<input type="checkbox"/>	<input type="checkbox"/>	
6				<input type="checkbox"/>	<input type="checkbox"/>	<input type="checkbox"/>	
7				<input type="checkbox"/>	<input type="checkbox"/>	<input type="checkbox"/>	
8				<input type="checkbox"/>	<input type="checkbox"/>	<input type="checkbox"/>	
9				<input type="checkbox"/>	<input type="checkbox"/>	<input type="checkbox"/>	
10				<input type="checkbox"/>	<input type="checkbox"/>	<input type="checkbox"/>	

\* FOR AMENDING EXISTING RECORDS, PLEASE TICK THIS BOX  AND DO NOT COMPLETE BOXES MARKED \* IF THAT DETAIL UNCHANGED. WARNING! TO ADD A NEW SUB-CODE, NEW VERSION MUST BE SHOWN.

SHEET OF SHEETS